

OLYMP FIREPLACE

INSTALLATIONS GUIDE

DANSK
FLASKE GAS

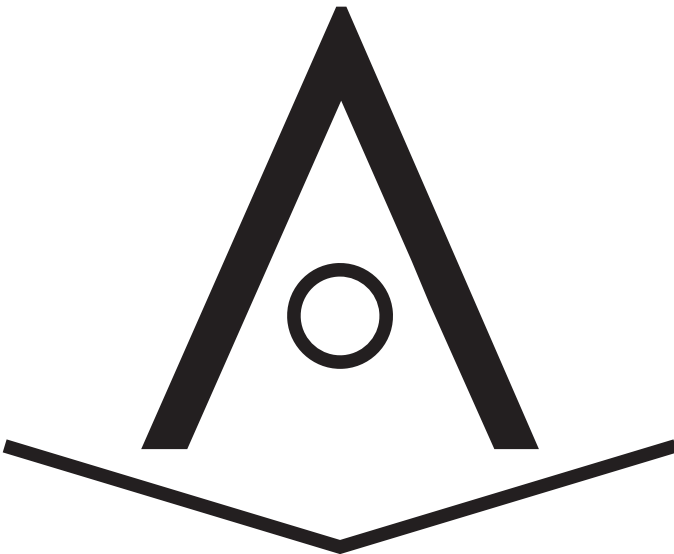

HADDELAND
DES·GN



Tak fordi du valgte Olymp Fireplace, designet af Haddeland Design.

Olymp Fireplace må kun anvendes til udendørs brug og skal installeres af en autoriseret gasmester og en autoriseret el-installatør.

Gas reglement og el-reglement skal overholdes.

INDHOLD:

1. Afstandskrav
2. Gas tilslutning - Flaske gas
3. EL
4. Opstart
5. Afbrydelse
6. Automatisk tænding, ekstra udstyr
7. Tekniske specifikationer
8. Reservedele - stykliste
9. Reklamation
10. Advarsler

⚠ WARNING



Asphyxiation Risk

- This gas log set is for outdoor use in a well-ventilated space.
- Log set must not be installed inside an enclosed structure or unvented appliance.

1. AFSTANDSKRAV

- Olymp Fireplace bålet må ikke overdækkes og afstanden fra faklens kant til brændbart materiale skal være minimum 1 m lodret og 0,5 m vandret.
- Kan afstanden ikke overholdes skal der monteres brandhæmmende fiberplader eller lignende.

2. TILSLUTNING AF FLASKE GAS

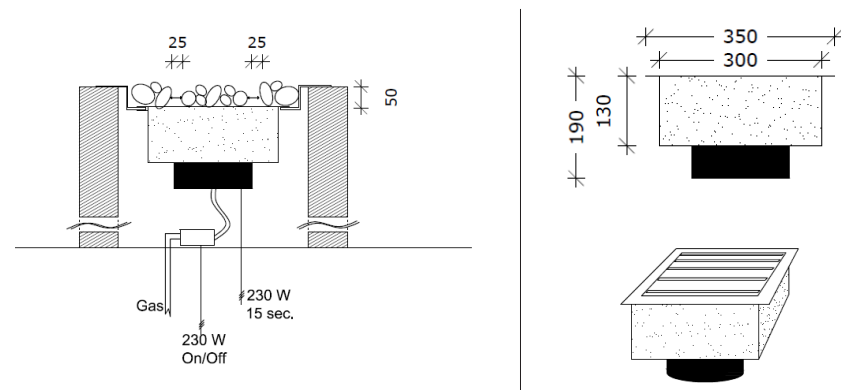

- Ved gasforsyningen monteres en 230 V~ gas magnetventil. Er afstanden til faklen/erne stor, kan det være nødvendigt, at montere en magnetventil umiddelbart foran faklen/erne.
- FLASKE GAS:
 - Monter slangen på slangestudsene på fakkelhovedet. I den anden ende monteres lyn koblingens nippel. Monter de medleverede spændebånd.
 - El-ledningen monteres på tænd blokken.
 - Hvis afstanden til flasken er mere end én meter, benyttes kobberør fra flasken og frem til magnetventilen.
 - Magnetventilen monteres under Olymp Fireplace sammen med kuglehanen.
 - Fra kuglehanen benyttes medfølgende slange.
- El-ledningen og kablet samles.
- Installationen trykprøves og efterses for utætheder.
- **Advarsel:** Ved afmontering af faklen skal el tilslutningen være afbrudt og ledningen i brønden skal demonteres før lyn koblingen adskilles.



3. EL

- Ledningen fra fakkelhovedet forbindes via det medleverede samlestick eller samledåse til et indvendigt impulstryk. **Husk at tilslutte "jord"**.
- Gas magnetventilen ved gasforsyningen forbindes med en indvendig afbryder.

4. OPSTART

- Åben for gasforsyningen.
- Åben for gas tilførslen ved at aktivere afbryderen.
- Tryk på impulstrykket i ca. 20 sekunder – flammen brænder.
(Vær opmærksom på, at der er luft i rør og slanger første gang faklen tændes)

5. AFBRYDELSE

- Afbryd gas magnetventilen ved den indvendige afbryder.

6. AUTOMATISK TÆNDING, EKSTRA Udstyr

















- Ved at montere et døgn- eller uge ur og en timer kan faklen tændes automatisk.
- Timeren stilles så faklen tændes i ca. 20 sekunder (max. 40 sekunder).
- Er der risiko for at faklen blæser ud kan timeren indstilles, så der gentændes for eksempel hvert kvarter. **(Må ikke gentænde med mindre interval end 10 minutter)**

7. TEKNISKE SPECIFIKATIONER

Tekniske data		F gas
Gasart		Kat.I3B/P
Gastryk	mbar	30
Dyse	mm	1,25
Gasforbrug		0,48 kg/h
Gas tilslutning		Lavtryksslange
El tilslutning	V ~	220 +10 % -15 %
Frekvens	Hz	50-60
Strøm	VA	28
Sikring	A	6
El kapslingsklasse	IP	44
Godkendelse		845BU-0027

Olymp Fireplace - HADDELAND DESIGN	
Q: 6,5 kW	Gas: Butan / Propan
<small>Cat: BG, CZ, CY, DK, EE, FI, HU, IS, LV, LT, MT, NL, NO, RO, SE, SI, SK, TR I_{app} 30 mbar Cat: BE, CH, ES, FR, GB, GR, IE, IT, LU, PT I_g, 28-37 mbar Cat: PL I_g 37 mbar</small>	
G30 - 30 mbar	 0845-12
ID: 845BU-0027	

8. RESERVEDELE - STYKLISTE

	Reserveparts stykliste	Antal	HD varenummer
	Brænder hoved	1	100
	Dyse	1	101 / 101N
	Tændspole	1	102
	Beslag for tændspole	2	103
	Slangespids	1	104
	Blok	1	105
	Møtrik til tændspole	1	106
	Slange	1	116
	Termo føler	1	107
	Tændeelektrode	1	108
	Magnet ventil	0	112
	Stik til tændspole	1	109
	Spændebånd	1	117
	Kuglehane	0	110
	El Boks	0	115
	Uge Ur	0	113
	Timer	0	114

Der tages forbehold for trykfejl og ændringer i tekniske specifikationer.

9. REKLAMATION

Ved reklamation indleveres Olymp Fireplace samt fakturaen til den forhandler, hvor den er købt. Forhandleren vil derefter behandle reklamationen.

Olymp Fireplace er omfattet af reklamationsret i henhold til købeloven gældende på købstidspunktet.

10. ADVARSLER

⚠ WARNING

Haddeland design disclaims any responsibility for, and the warranty will be voided by, the following actions:

- ° Installation and use of any damaged components.
- ° Modification of the burner or log assemblies.
- ° Installation other than using an authorized gas fitter.
- ° Improper positioning of the gas logs.
- ° Installation and/or use of any component parts not approved by Haddeland Design.

Any such actions may cause a fire hazard

⚠ WARNING

If the information in these instructions is not followed exactly, a fire may result causing property damage, personal injury, or death.

- Do not store or use gasoline or other flammable vapors and liquids in the vicinity of this or any other appliance.
- **What to do if you smell gas:**
 - Do not try to light any appliance.
 - Do not touch any electrical switch. Do not use any phone in your building.
 - Immediately call your gas supplier from a neighbor's phone. Follow the gas supplier's instructions.
 - If you cannot reach your gas supplier, call the fire department.
- Installation and service must be performed by a qualified installer, service agency, or the gas supplier.

⚠ WARNING

HOT! DO NOT TOUCH. SEVERE BURNS MAY RESULT. CLOTHING IGNITION MAY RESULT.

Glass and other surfaces are hot during operation and cool down.

- Keep children away.
- CAREFULLY SUPERVISE children in same room as appliance.
- Alert children and adults to hazards of high temperatures.
- Keep clothing, furniture, draperies and other combustibles away.

⚠ WARNING

CHECK FOR GAS LEAKS
Fire Risk
Explosion Risk
Asphyxiation Risk

- Check all fittings and connections.
- Do not use open flame.
- After the gas line installation is complete, all connections must be tightened and checked for leaks with a commercially available, non-corrosive leak check solution. Be sure to rinse off all leak check solution following testing.

Fittings and connections may have loosened during shipping and handling.

⚠ WARNING

Asphyxiation Risk

- This gas log set is for outdoor use in a well-ventilated space.
- Log set must not be installed inside an enclosed structure or unvented appliance.

 **WARNING**

 Inspect appliance and components for damage. Damaged parts may impair safe operation.

- Do NOT install damaged components.
- Do NOT install incomplete components.
- Do NOT install substitute components.

 Report damaged parts to dealer.

 **WARNING**

 **Fire Risk**
Explosion Risk

Verify inlet pressures.

- High pressure may cause overfire condition.
- Low pressure may cause explosion.
- Verify minimum pressures when other household gas appliances are operating.

Install regulator upstream of valve if line pressure is greater than 1/2 psig.

 **WARNING**

 **Fire Risk**
Explosion Risk

- Gas build-up during line purge may ignite.
- Purge should be performed by qualified technician.
- Ensure adequate ventilation.
- Ensure there are no ignition sources such as sparks or open flames.

 **WARNING**

Do NOT use this appliance if any part has been under water. Immediately call a qualified service technician to inspect the appliance and to replace any part of the control system and any gas control which has been under water.



**OLYMP
FIREPLACE**